

QUELARC[®] 100 AMP 600 VAC

2 POLE 3 WIRE
SOLDER CONTACTS
1.000" TO 1.375" CABLE RANGE

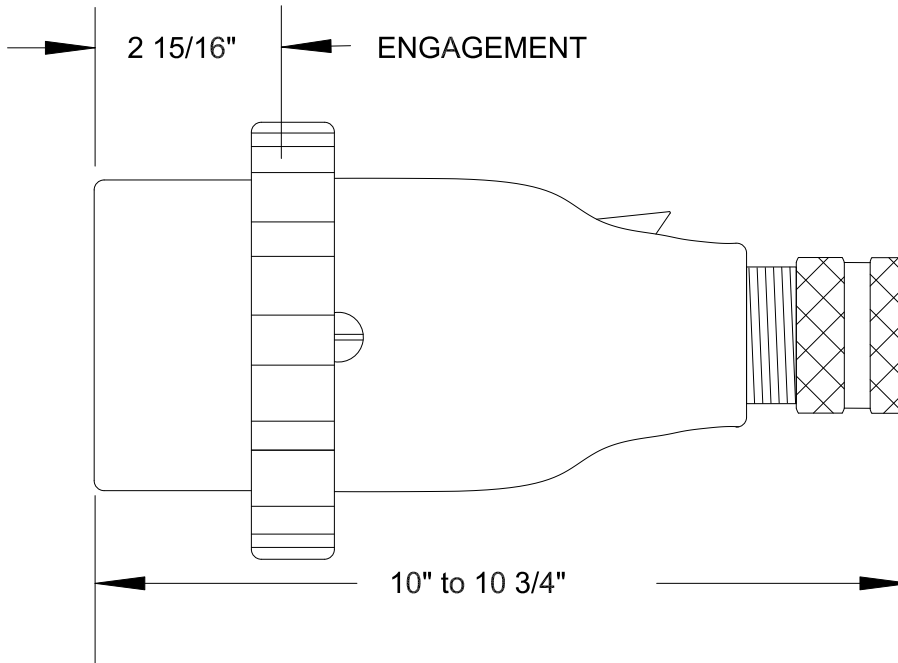
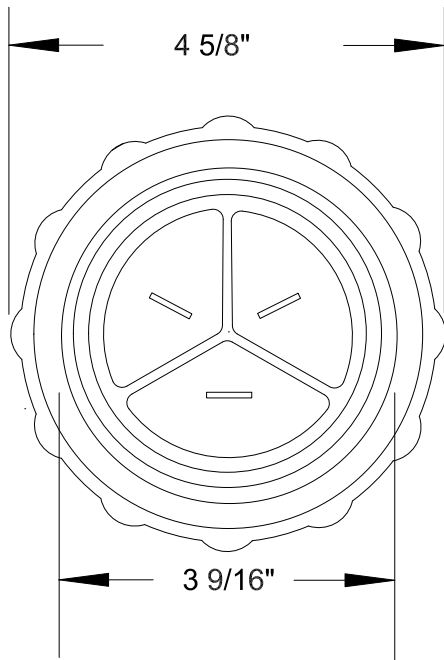

To order contact:
 HILLCREST ENTERPRISES, INC.
 11092 AIR PARK ROAD
 ASHLAND, VA 23005 USA

Phone: 804-798-8390
 Fax: 804-752-7830

<http://www.pylenational.co>
<http://www.plugs.cc>

DRAWING NOT TO SCALE

DRAWN BY NVS	HILLCREST ENTERPRISES		
APPROVED 4/14	JPLD-1110036		
ISSUED			
RECORD OF ISSUE	SCALE	DRG No.	SHEET
			1 OF 1