

# QUELARC<sup>®</sup> 60 AMP 600 VAC

2 POLE 3 WIRE
PRESSURE CONTACTS
1 1/2" NPT

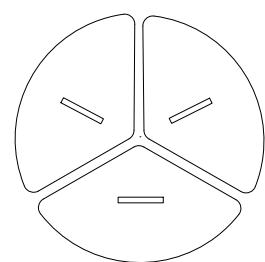
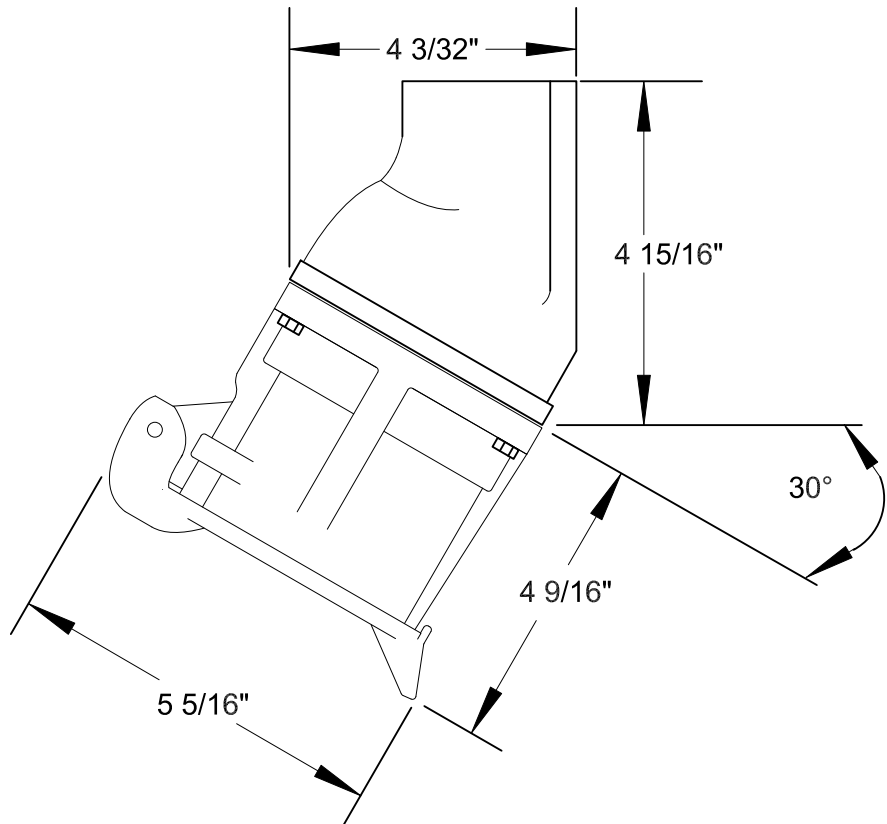
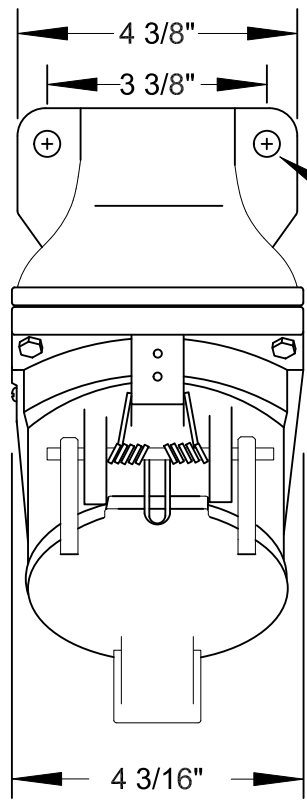

RECEPTACLE FACE  
DRAWING NOT TO SCALE

To order contact:  
HILLCREST ENTERPRISES, INC.  
11092 AIR PARK ROAD  
ASHLAND, VA 23005 USA

Phone: 804-798-8390  
Fax: 804-752-7830

<http://www.pylenational.co>  
<http://www.plugs.cc>

DRAWN BY	NVS	HILLCREST ENTERPRISES		
APPROVED	4/14	<b>JRCBB-56036-PR</b>		
ISSUED				
RECORD OF ISSUE		SCALE	DRG No.	SHEET
				1 OF 1