

QUELARC[®] 30 AMP 600 VAC

4 POLE 4 WIRE
PRESSURE CONTACTS

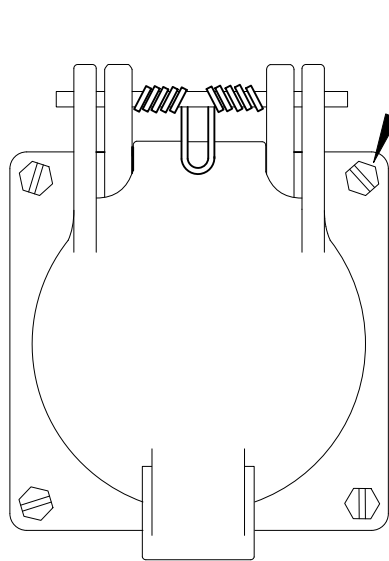

1/4" - 20

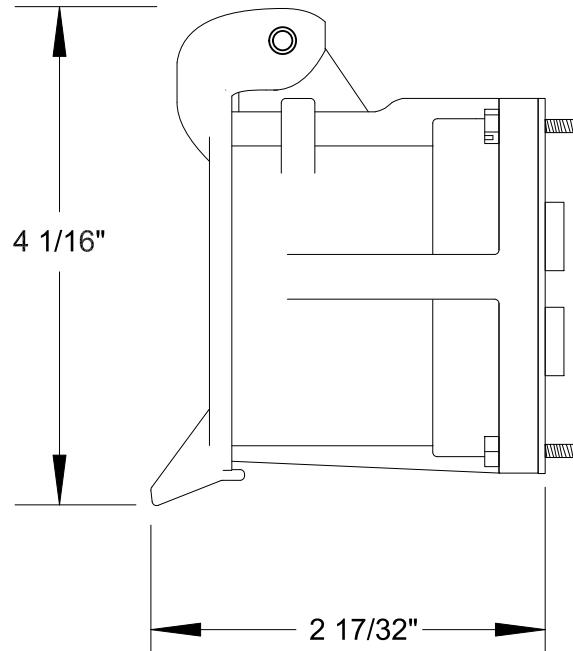

4 1/16"

2 17/32"

BORE OF PANEL
2 3/32"

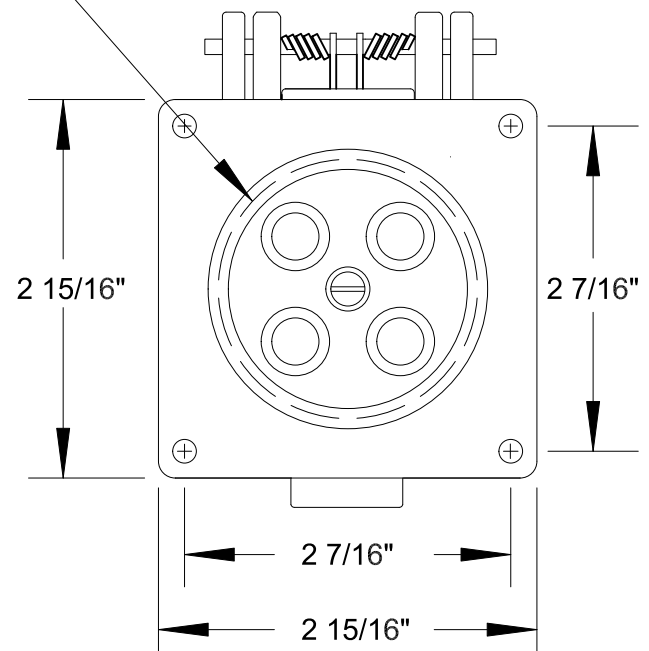

2 15/16"

2 7/16"

2 7/16"

2 15/16"

To order contact:
HILLCREST ENTERPRISES, INC.
11092 AIR PARK ROAD
ASHLAND, VA 23005 USA

Phone: 804-798-8390
Fax: 804-752-7830

<http://www.pylenational.co>
<http://www.plugs.cc>

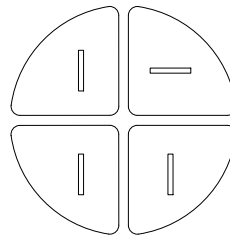

RECEPTACLE FACE

DRAWING NOT TO SCALE

DRAWN BY NVS

 HILLCREST ENTERPRISES

APPROVED 3/15

KRC-430-PR

ISSUED

RECORD OF ISSUE

SCALE

DRG No.

SHEET

1 OF 1