

QUELARC[®] 60 AMP 600 VAC

3 POLE 3 WIRE
SOLDER CONTACTS
1 1/4" NPT

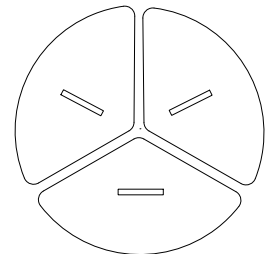
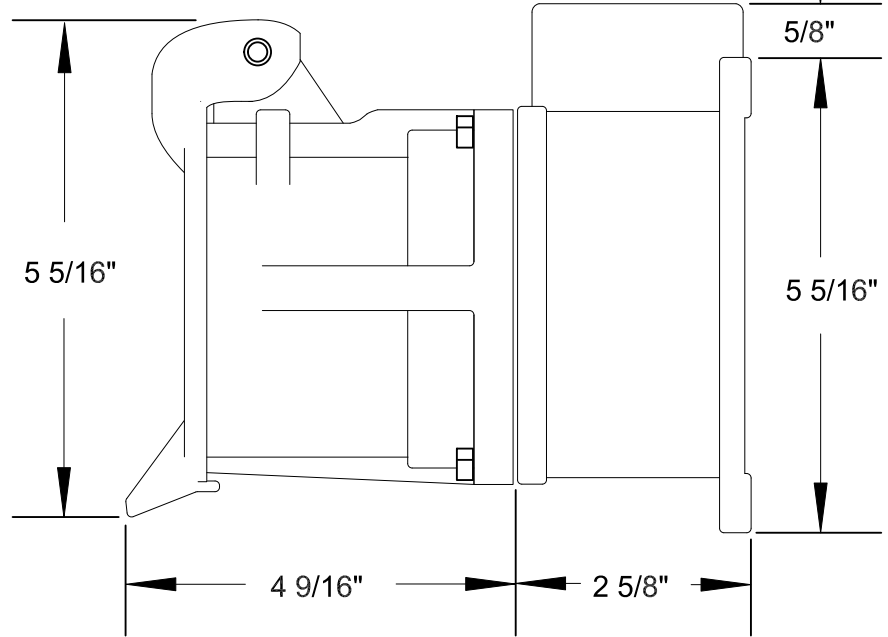
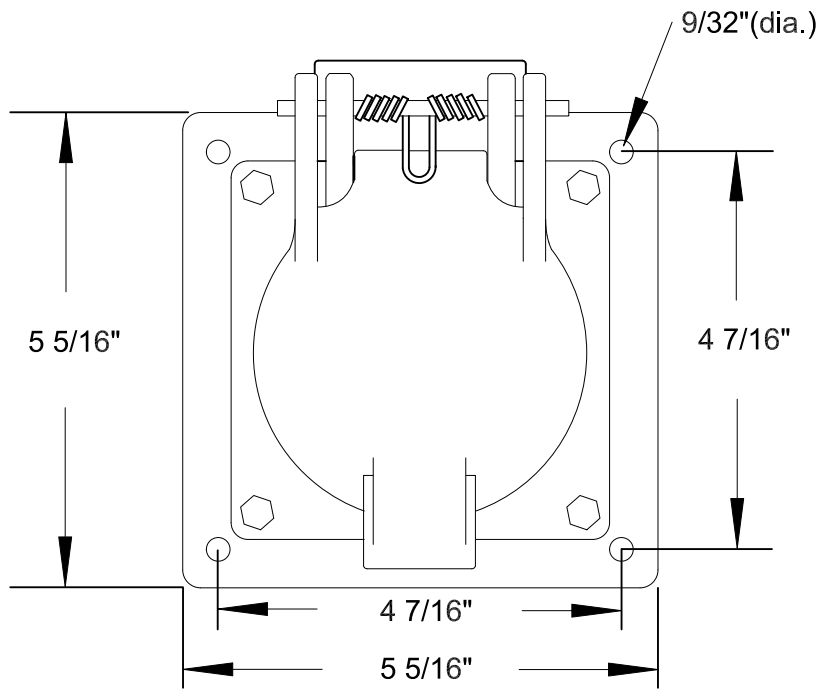

RECEPTACLE FACE
DRAWING NOT TO SCALE

To order contact:
HILLCREST ENTERPRISES, INC.
11092 AIR PARK ROAD
ASHLAND, VA 23005 USA

Phone: 804-798-8390
Fax: 804-752-7830

<http://www.pylenational.co>
<http://www.plugs.cc>

DRAWN BY	NVS	HILLCREST ENTERPRISES		
APPROVED	4/14	KRCA-46036		
ISSUED				
RECORD OF ISSUE		SCALE	DRG No.	SHEET
				1 OF 1