

QUELARC[®] 30 AMP 600 VAC

3 POLE 3 WIRE
PRESSURE CONTACTS
1/2" NPT

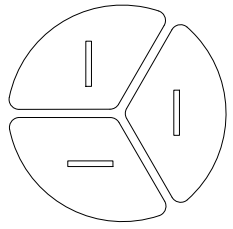
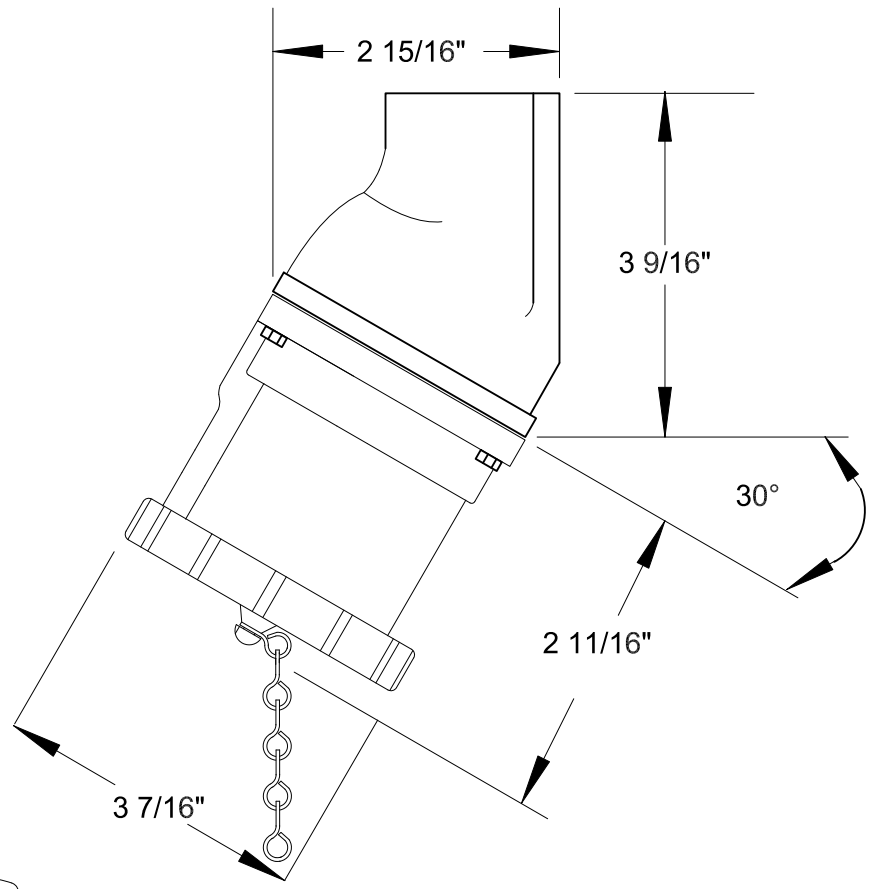
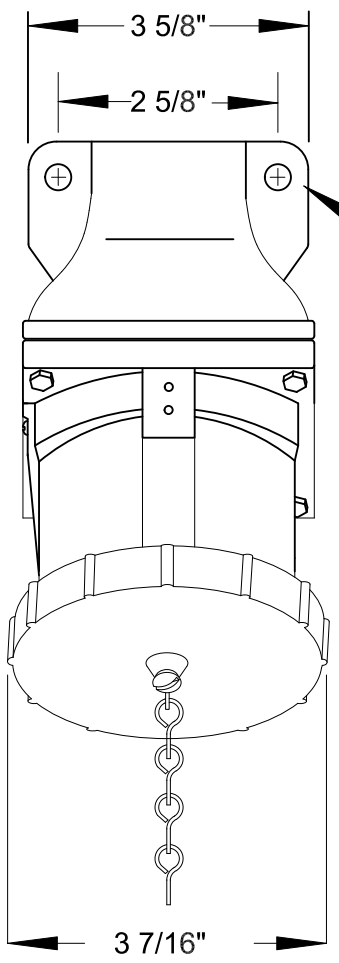

RECEPTACLE FACE
DRAWING NOT TO SCALE

To order contact:
HILLCREST ENTERPRISES, INC.
11092 AIR PARK ROAD
ASHLAND, VA 23005 USA

Phone: 804-798-8390
Fax: 804-752-7830

<http://www.pylenational.co>
<http://www.plugs.cc>

DRAWN BY	NVS	HILLCREST ENTERPRISES		
APPROVED	3/15			
ISSUED		KREBB-13036-PR		
RECORD OF ISSUE				
		SCALE	DRG No.	SHEET
				1 OF 1