

QUELARC[®] 60 AMP 600 VAC

| |
|------------------------------|
| 3 POLE 3 WIRE |
| PRESSURE CONTACTS |
| 1.000" TO 1.375" CABLE RANGE |

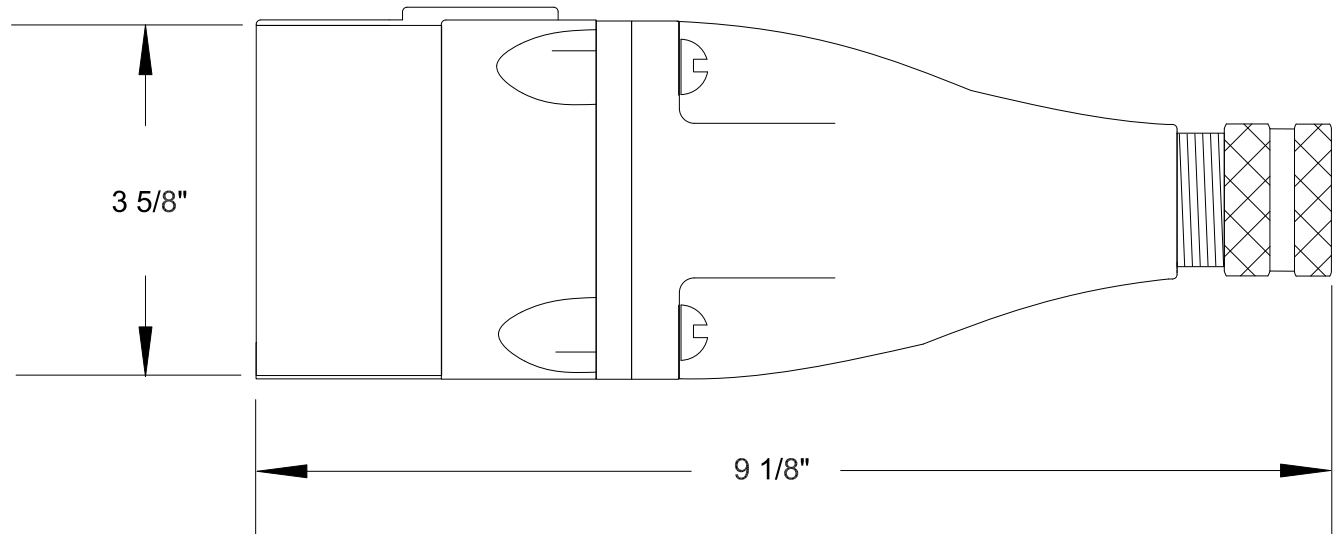
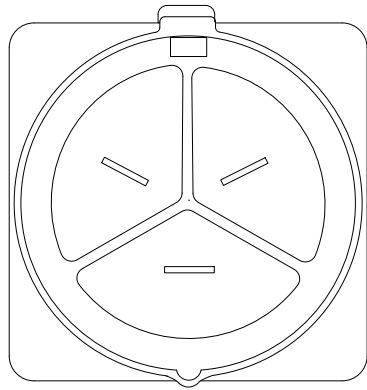

To order contact:
HILLCREST ENTERPRISES, INC.
 11092 AIR PARK ROAD
 ASHLAND, VA 23005 USA

Phone: 804-798-8390
 Fax: 804-752-7830

<http://www.pylenational.co>
<http://www.plugs.cc>

DRAWING NOT TO SCALE

| | | | | |
|-----------------|------|---|---------|--------|
| DRAWN BY | NVS |  HILLCREST ENTERPRISES | | |
| APPROVED | 2/15 | KWPD-116036-PR | | |
| ISSUED | | | | |
| RECORD OF ISSUE | | SCALE | DRG No. | SHEET |
| | | | | 1 OF 1 |